

User's Guide

Service Addendum

Amiga CD³²

July 1993

371223-01

In memory to Jay Miner and all developers of the Amiga system! Let the spirit survive!

Any commercial use of this material is prohibited!

Table of Contents

Introduction

Amiga CD32 System Specifications.....	v
Using This Guide	vi

Chapter 1

Customer Information

Connecting a Television/Monitor	1-2
The Game Controller	1-4
Using the Amiga CD32 Software	1-4
Playing Audio CDs.....	1-4
Selecting a Language.....	1-4
Locking Game Information	1-4

Chapter 2

Replacing Field Replaceable Units (FRUs)

Replacing the Power Supply and Game Controller	2-1
Separating and Connecting the System Top and Bottom Cases.....	2-1
Replacing the Motherboard.....	2-3
Replacing the Bottom Case.....	2-4
Replacing the CD Drive.....	2-4
Replacing the CD Drive Cable	2-4
Replacing the LED Board	2-5
Replacing the LED Board Cable.....	2-5
Replacing the Hinge and Case Top Lid	2-5

Chapter 3

Installing ROM Upgrade

Before You Begin.....	3-1
Installing the ROM Upgrade	3-1

Chapter 4

System Specifications

System Block Diagram.....	4-2
System Memory Map.....	4-3
External Connector Pinouts	4-4
Video Connector Pinout.....	4-4
RF Modulator Jack	4-4
S-video Part (4-pin mini-DIN).....	4-4
Color Composite Video (RCA Jack)	4-4
Audio Ports	4-4
Stereo Audio Ports	4-4
Headphone Jack	4-5
Expansion Connector Pinouts.....	4-5
Game Ports 1 and 2.....	4-5
Auxiliary Serial/Keyboard Port (6-pin mini-DIN)	4-5
Power Connector (4-pin DIN).....	4-6
Expansion Connector	4-6
Akiko Specification	4-11
Configuration	4-11
Sources	4-11
Applicable Documents.....	4-11
Pinouts	4-12
PHYSICAL REQUIREMENTS.....	4-16
Marking.....	4-16
Packaging.....	4-16
Minimum Acceptance Level.....	4-16
Age Of Devices.....	4-16

Chapter 5

Bill of Materials

Chapter 6

Schematics

Amiga CD32 PCB Assembly Schematics.....	6-1
---	-----

Errata

User's Guide/Service Addendum (P/N 371223-01)

Page 4-5

Replace the drawing of the auxiliary serial/keyboard port (6-pin mini-DIN) with the following:

Auxiliary Serial/Keyboard Port (6-pin mini-DIN)

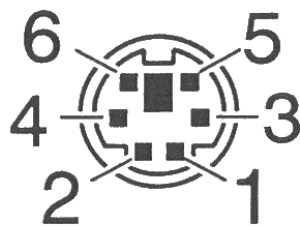

Introduction

The Amiga CD³² is a 32-bit system designed to play CD games and audio discs. Planned expansion options include a full motion video module and computer expansion unit.

Amiga CD³² System Specifications

- Motorola® 68EC020, 32-bit microprocessor 14 MHz clock speed
- 2 MB, 32-bit Chip RAM
- 1 MB system ROM containing AmigaDOS
- Top loading CD-ROM double-speed drive
- Advanced Graphics Architecture™ custom chip set support for:
 - 256,000 screen colors from a palette of 16.8 million colors
 - Resolutions up to 800 x 600
 - Eight 64-bit sprites
 - Two graphics accelerator co-processors
- Video display support for:
 - S-video for TV
 - PAL and NTSC composite video monitor or TV
 - PAL and NTSC RF modulator output for TV
- Audio support for:
 - Four channel stereo sound
 - 8-bit digital/analog converters
 - 16-bit audio CD stereo at 44 kHz
 - Headphone jack
 - Sliding volume control

- Interfaces include:
 - Eleven switch game controller (included with system)
 - Two game controller/joystick/mouse ports
 - High speed auxiliary connector for serial devices
 - 182-pin expansion connector for Amiga computer module and Amiga CD³² full motion video module
- External brick-type 22 watt power supply
- Supported CD types include Amiga CD³², Audio CD, CD+G and CDTV™
- System dimensions—21.2 cm deep x 31.1 cm wide x 8.1 cm high
- System unit weight—1.44 kg
- Power supply weight—1.53 kg

Using This Guide

You'll find instructions similar to those the user receives for connecting and operation the system in Chapter 1. The additional chapters provide instructions for upgrading and repairing the Amiga CD³² system.

Chapter 1, Customer Information, provides instructions for connecting and operating the system.

Chapter 2, Replacing the Field Replaceable Units (FRUs), gives you instructions on how to remove and replace field replaceable sub-assemblies.

Chapter 3, Installing ROM Upgrade, tells you how to remove and install the ROM on the motherboard.

Chapter 4, Amiga CD³² System Specifications, provides technical details about the system including a memory map, block diagrams, pinouts, and ASIC specifications.

Chapter 5, Bill of Materials (BOM), gives the part numbers for items on the BOM and highlights the part numbers for the FRUs.

Chapter 6, Schematics, provides PCB assembly schematics.

Chapter 1

Customer Information

This chapter summarizes the information the customer receives. This includes basic setup instructions and software operations. The Amiga CD³² system comes with the items illustrated in Figure 1-1.

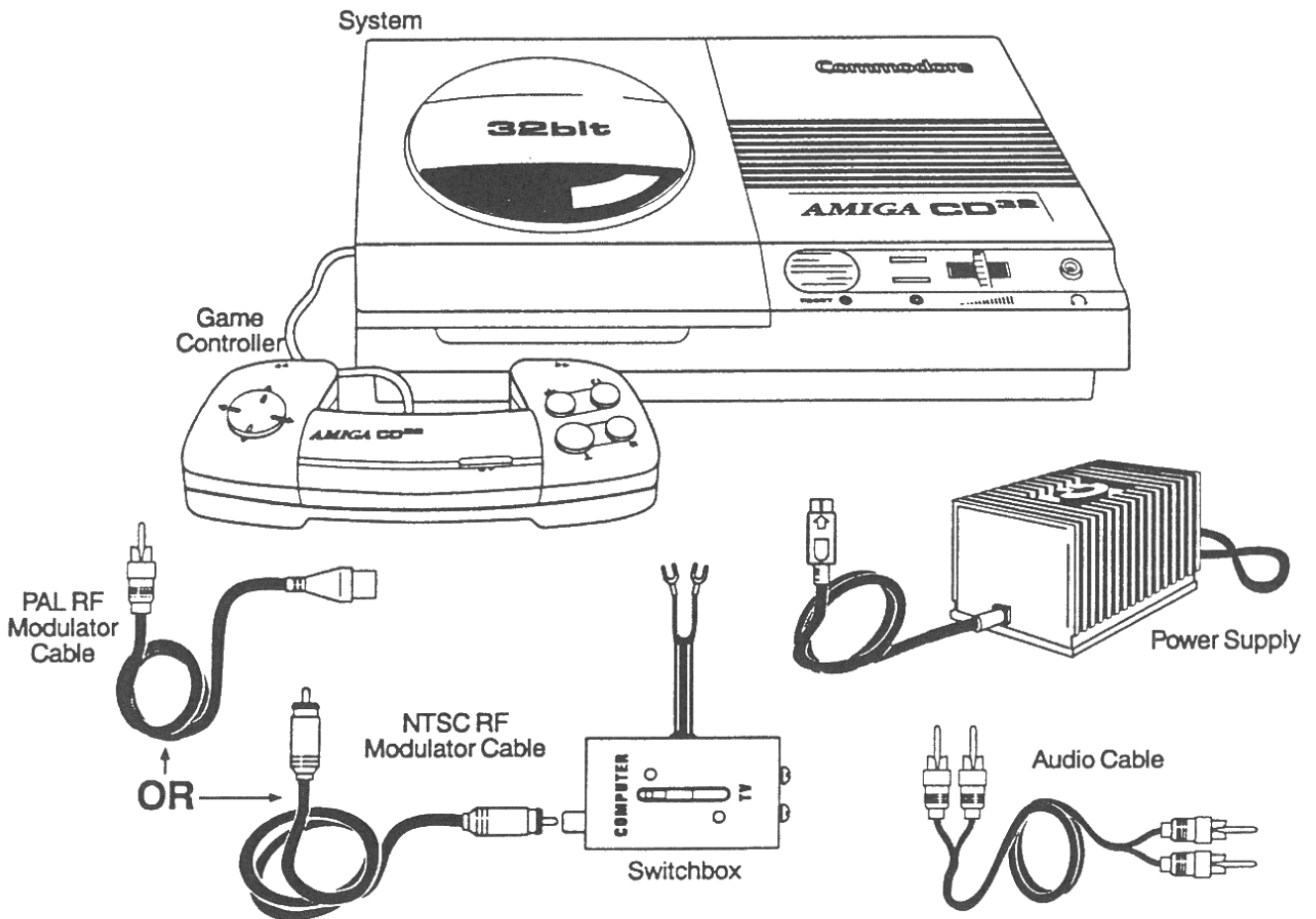

Figure 1-1. Amiga CD³² System

Connecting a Television/Monitor

The easiest way to connect the Amiga CD³² system to a television/monitor is to use the RF modulator that provides all the video and audio connections necessary. For a PAL system: Use the provided RF modulator cable. For a NTSC system use the provided RF switch box to connect a television/monitor with a VHF cable (F-type) connector and 75Ω antenna, cable or VCR cable. The NTSC system requires a 300/75Ω converter for an antenna or rabbit ears with twin lead wire and a 75/300Ω converter for VHF screw type connectors.

S-video and composite video are options, but require the customer to purchase additional specialized cables. The customer is referred to his TV documents in order to determine whether his set is S-video or composite video compatible.

The stereo audio cables allow the customer to connect to TV stereo, powered speakers, or standard stereo output.

See Figure 1-2 for the location of the side and rear panel features.

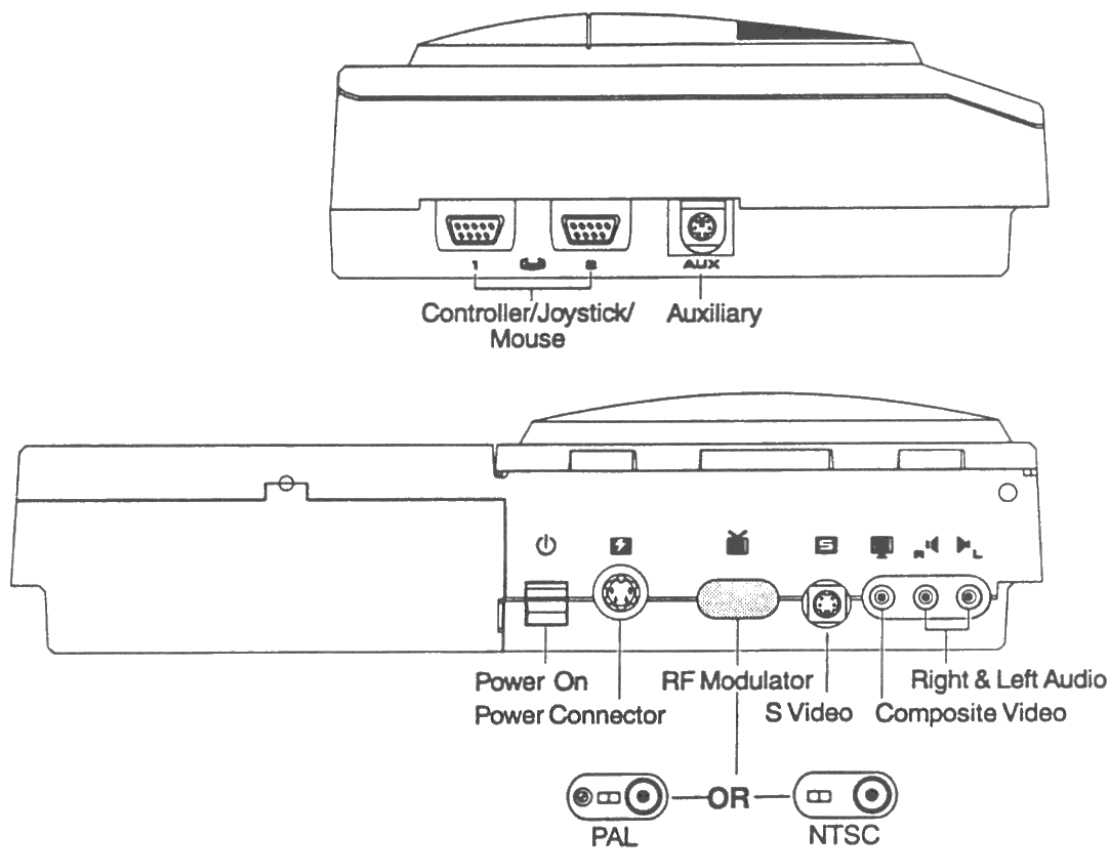

Figure 1-2. Side and Rear Panels

Table 1-1 lists each socket on the system unit side and rear panels and summarizes the information provided to the customer.

Table 1-1. Side and Rear Panel Connectors

Connector	Description
Game Controller Connector	Plug the game controller into socket 1. To use a second game controller, joystick or mouse, plug it into socket 2. Don't plug or unplug a controller while the power is on.
Auxiliary Connector	To use keyboard or another device, plug it into the socket marked AUX.
RF Connector	<p>Plug the RF modulator cable into the jack and the other end into the television/monitor.</p> <p>For a PAL system:</p> <p>Set the switch to the left (5.5 mHz) for the United Kingdom and to the right (6.0 mHz) for all other countries.</p> <p>If the television/monitor picture is not clear, use a small flat-bladed screwdriver to turn the screw until the picture is in sharp focus.</p> <p>For a NTSC system:</p> <p>Set the switch to left for channel 3 and or the right for channel 4, whichever is not used in your geographical area.</p> <p>For both systems use the television/monitor volume control to adjust the sound.</p>
S-video Connector	To use S-video, the customer must buy an S-video cable with a 4-pin mini-DIN connector at each end. Plug one end of the cable into the socket under the symbol and the other into the television/monitor.
Composite Video Connector	To use composite video, the customer must buy a composite video cable with an RCA plug at each end. Plug one end of the cable into the yellow socket and the other into the television/monitor.
Right and Left Audio Connectors	<p>If the customer has a stereo television/monitor, he can use the stereo audio cables shipped with the system. Plug the white cable into the white socket and the other cable into the red socket. Connect the other end to the television/monitor.</p> <p>If the customer wants to connect a television/monitor with mono sound, he should plug the white cable into the white socket under the symbol. Do not connect the other cable. Plug the white cable on the other end into the television/monitor.</p>

Plug in the power supply and turn on the system only after securely connecting these options. In the United Kingdom manual, the customer is told to have a certified electrician attach the correct plug to the cable.

The control panel in the front of the machine contains the reset button, power and disk activity lights, headset jack and headset volume control.

The Game Controller

The system comes with a customized game controller that has four play buttons, a pause/start bar, two general feature bars and an omni-directional movement button. The controller is used for controlling game play, making audio selections and defining system set-up options..

Using the Amiga CD³² Software

Once the system has been turned on, you can change CDs by just lifting the lid and the disc stops spinning. The system starts again when you close the lid.

- If you put an Amiga CD³² game in the drive the logo screen appears for a few seconds while the game loads. Then the game starts.
- If you put an audio CD in the drive you'll see the audio control display.
- If there is no CD in the drive you'll see the Amiga CD³² logo screen.

Playing Audio CDs

The user can play an audio CD in one of two ways: from the controller or from the audio display. The easiest way is to press the appropriate button on the controller. The function symbols associated with the buttons are identical to those on the display. The other way is to highlight the appropriate box on the display and press the red button to select it. Use the black directional button to move the highlight around the display.

Selecting a Language

From the logo screen press the blue button to see the language selection screen. Choose a preferred language for game playing on this screen. This is a one time selection.

Locking Game Information

From the logo screen press the red button to see the gamelock screen. The Amiga CD³² can save 100 memory units worth of game information. This screen allows the user to protect old game information from being deleted or replaced by other game information by "locking" it.

Chapter 2

Replacing Field Replaceable Units (FRUs)

This chapter gives instructions for removing and replacing the following FRUs:

- Power supply (part number 313375-01 to 313375-06)
- Game controller (part number 365183-01)
- System motherboard (part number 365101-02 PAL or 365101-01 NTSC)
- Bottom Case Assembly (part number 365159-01, see Chapter 5 for individual part numbers)
- CD drive cable (part number 313376-01)
- CD drive assembly (part number 365161-01)
- LED cable (part number 365367-01)
- LED board assembly (part number 365168-01)
- Top Case Assembly (part number 365160-01, see Chapter 5 for individual part numbers)

Order replacements according to the procedures established by your service organization.

Replacing the Power Supply and Game Controller

If the power supply or game controller is defective replace it with a new item.

Separating and Connecting the System Top and Bottom Cases

To remove the system top case:

1. Turn off the power switch and remove all connecting cables.
2. Remove the system case screws. Remove the case screw on the rear panel as illustrated in Figure 1-2. Turn the system over and remove the five screws on the bottom of the case.
3. Turn the system over while holding the system bottom case firmly to the system top case.

4. The CD drive assembly and LED board are connected to the top case and their cables attach to the motherboard in the bottom case. Very carefully lift up the top case from the bottom case a few inches.
5. Remove the LED board cable from the LED board installed in the top system case. Locate the LED board cable in Figure 2-1. Grasp the connector by the outside edges. Pull it out of the socket and lift the cable out of the niche behind the tab in the bottom of the system case. Make certain to place the cable behind the tab on the bottom of the system case when replugging it into the LED board.

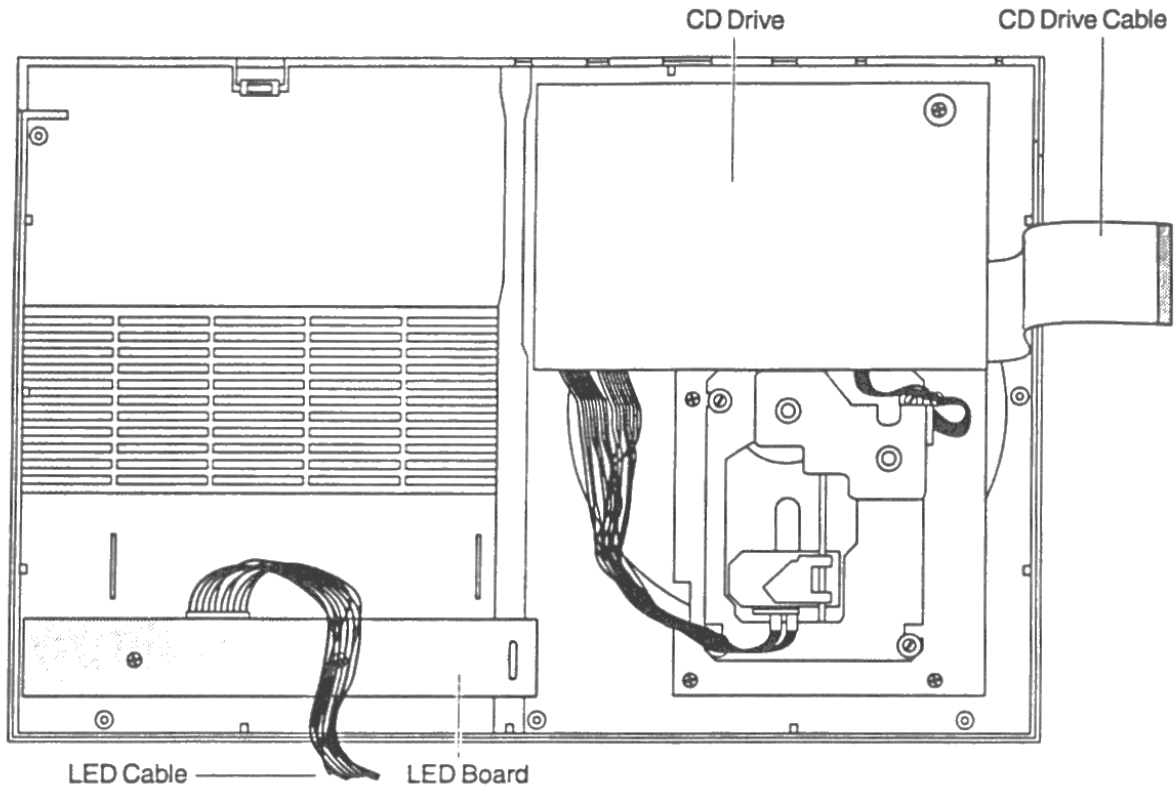

Figure 2-1. CD Player and LED Board Location and Cables

6. Flip the top case up at a 90° angle to expose the inside of the top and bottom cases.
7. Remove the LED board cable from the motherboard. Locate the LED board cable socket on the bottom of the case in Figure 2-2. Make certain to place the cable behind the tab on the bottom of the system case when replugging it into the motherboard.

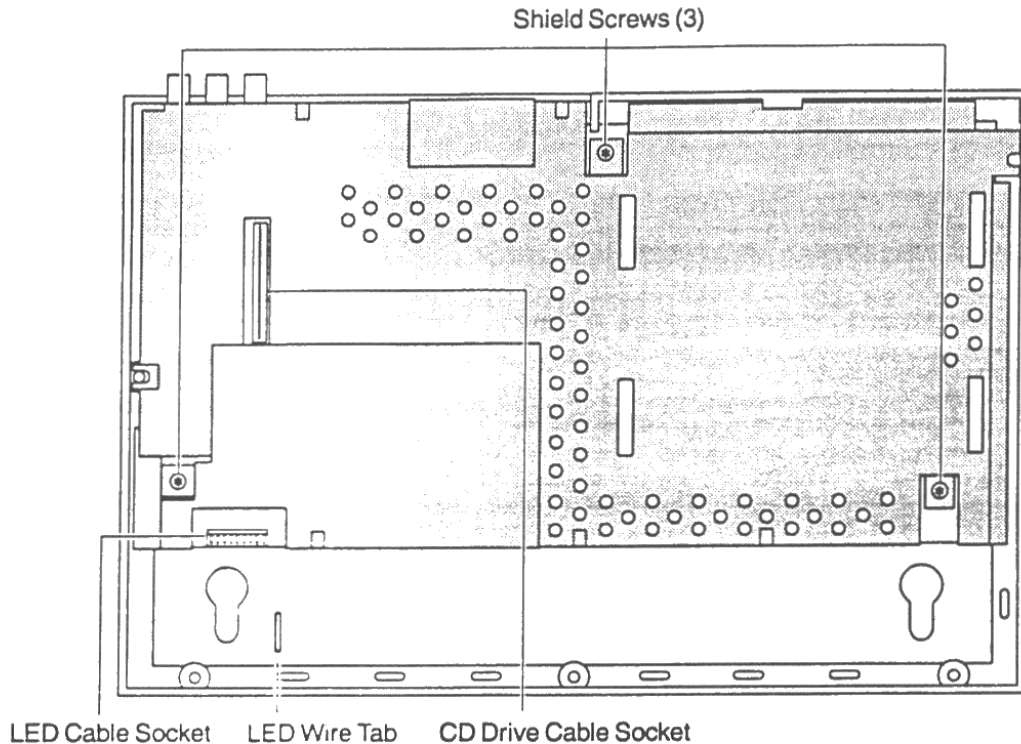

Figure 2-2. Motherboard Shield and Cable Socket Locations

8. Remove the CD drive cable from the motherboard. Locate the CD drive cable socket on the motherboard in Figure 2-2. The socket may be an insertion socket or a ZIF socket. Grasp the cable firmly and pull it out of the socket. To insert the cable into an insertion socket, grasp the flat ribbon cable and push it straight into the socket. To insert the cable into a ZIF socket, first grasp the socket on its outside edges with a needle-nose pliers and pull the socket up to release it. Then grasp the flat ribbon cable and push it straight into the socket. Push the socket down to lock the cable in place.
9. Reverse this procedure to reassemble the top and bottom cases.

Replacing the Motherboard

Follow the instructions for removing the system top case on page 2-1.

To remove and replace the motherboard:

1. Locate the three shield screws on Figure 2-2 and remove the screws.
2. Lift the shield out of the case.

3. Bend the shield tabs to a 90° angle and remove the top shield.
4. Lift the motherboard out of the bottom shield and replace it.
5. Reverse the preceding steps to reassemble the case.

Replacing the Bottom Case

Follow the instructions for removing the system top case on page 2-1.

To replace the bottom case:

1. Remove the shield containing the mother board by following steps 1 and 2 under "Replacing the Motherboard" page 2-3.
2. Replace the shield and motherboard in a new case.
3. Reverse the preceding steps to reassemble the case.

Replacing the CD Drive

Follow the instructions for removing the system top case on page 2-1.

To remove and replace the CD drive:

1. Locate the five CD drive screws on Figure 2-1 and remove the screws.
2. Lift the CD drive out of the top case and replace it.
3. Reverse the preceding steps to reassemble the case.

Replacing the CD Drive Cable

Follow the instructions for removing the system top case on page 2-1.

Follow the instructions for removing the CD Drive on page 2-4.

To remove and replace the CD Drive cable.

1. Locate the CD drive cable on the drive in Figure 2-2. Grasp the flat ribbon cable on the outside edges near the socket and pull it straight out of the socket. To insert the cable, grasp the flat ribbon cable on the outside edges near the socket and push it straight out of the socket. Make certain that the cable is firmly seated in the socket.
2. Reverse this procedure to reassemble the top and bottom cases.

Replacing the LED Board

Follow the instructions for removing the system top case on page 2-1.

1. Locate the two LED board screws on Figure 2-2 and remove the screws.
2. Lift the LED board out of the top case and replace it.
3. Reverse the preceding steps to reassemble the case.

Replacing the LED Board Cable

Follow the instructions for removing the system top case on page 2-1.

To remove and replace the LED board cable connected to the LED board:

1. Grasp the connector by the outside edges and pull it straight up and out of the socket.
2. Reverse the preceding steps to replace the cable.

Replacing the Hinge and Case Top Lid

To remove and replace the case top lid:

1. Locate the hinge pin screw illustrated in Figure 2-3 and remove the screw.

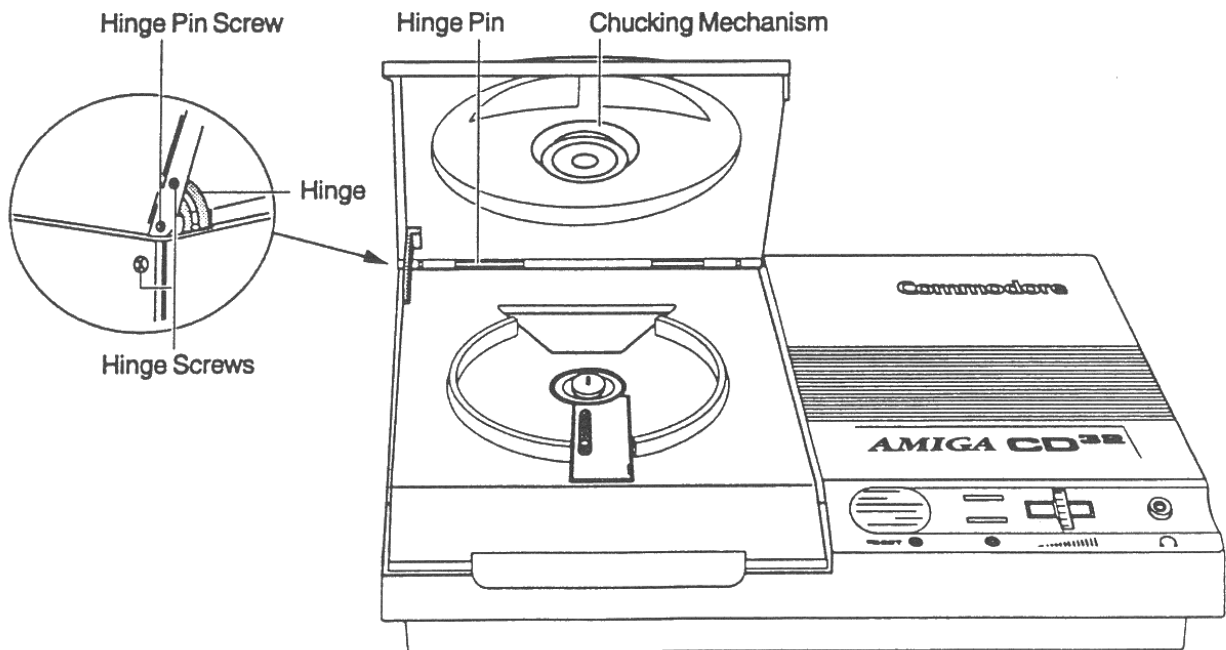

Figure 2-3. Hinge and Case Lid

2. Remove the hinge pin. If necessary, use a needle-nose pliers to work the hinge pin out of the hinge.
3. Locate the two hinge screws illustrated in Figure 2-3 and remove the screws.
4. Remove the hinge.
5. Replace the lid with the attached chucking mechanism.
6. Reverse the preceding steps to reassemble the case top lid.

Chapter 3

Installing ROM Upgrade

A ROM chip upgrade can enhance the functionality of the Amiga CD³² system.

Before You Begin

When removing and replacing the ROM chip:

- Turn off the power on your system.
- Disconnect all external cables from your system unit.
- Remove the system unit cover, as explained in Chapter 2.
- Remove the motherboard from the shield case, as explained in Chapter 2.
- Follow the instructions in this chapter to install ROM upgrade option.

Installing the ROM Upgrade

When replacing the ROM chip:

1. Locate the chip on the motherboard, as illustrated in Figure 3-1.

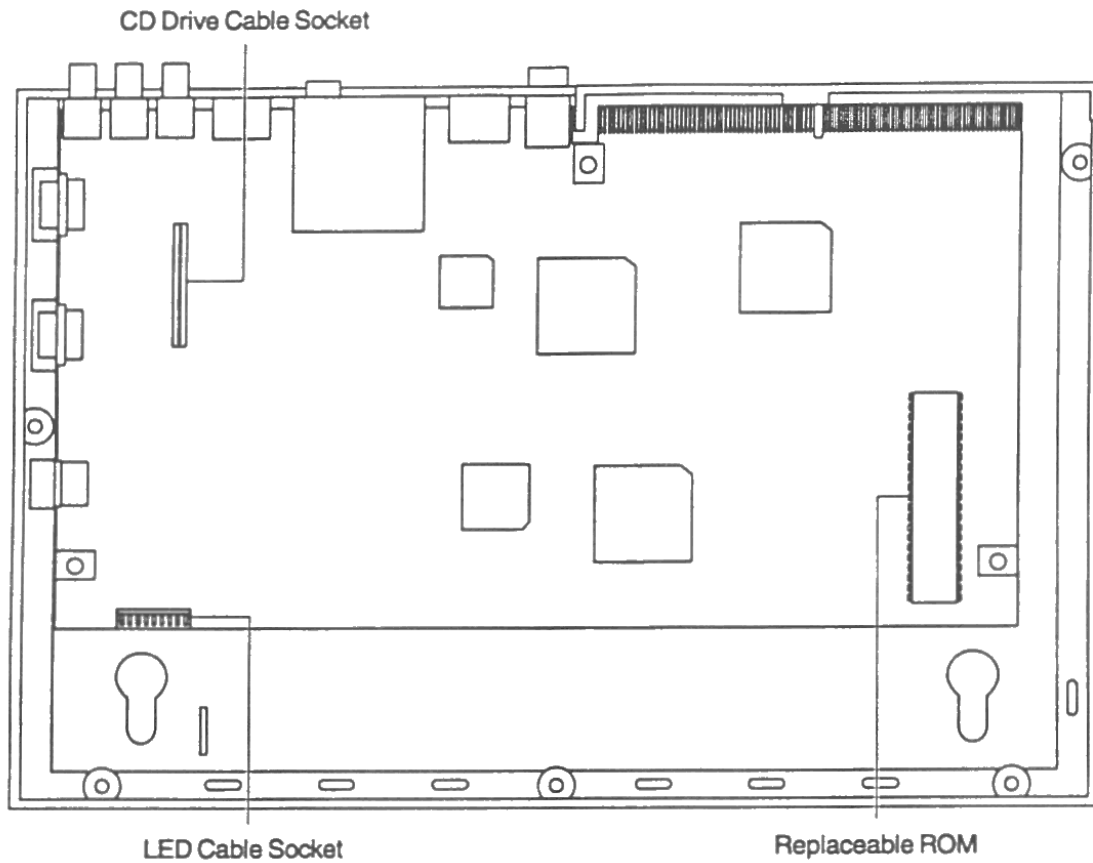

Figure 3-1. ROM Chip Location

2. Remove the ROM chip using a chip pulling tool.
3. Locate the U notch on the end of the ROM socket, as illustrated in Figure 3-1.
4. Locate the U notch on the end of the new ROM chip. Orient the chip above the socket.
5. Align the legs on the chip with the holes in the socket.
6. Insert the chip in the socket. Press firmly, but do not force.
7. Reassemble the system by reversing the steps on page 3-1.

Chapter 4

System Specifications

The Amiga CD³² is an entry level, 32-bit CD game machine based on a 68EC020 microprocessor and the AGA (Advanced Graphics Architecture) chip set also known as AA (pronounced "double A"). Basically the system is a cost reduced CDTV with a top loading CD-ROM drive based on a streamlined A1200 motherboard.

The Amiga CD³² introduces a new gate array, Akiko, that acts as an interface:

- Between the processor and the custom chips
- For talking to a CD drive
- For accelerating Chunky to Planar pixel conversion

An optional expansion box converts the Amiga CD³² into a complete Amiga computer with a floppy disk drive, standard interface connectors, expansion slot space for a hard disk and Fast RAM upgrades.

The optional Amiga CD³² Full Motion Video module provides over seventy minutes of TV-quality video.

This chapter provides technical details about the Amiga CD³² system including:

- Block diagram
- System memory map
- Pinouts
- Akiko specification

System Block Diagram

Refer to Figure 4-1 for the Amiga CD³² system block diagram.

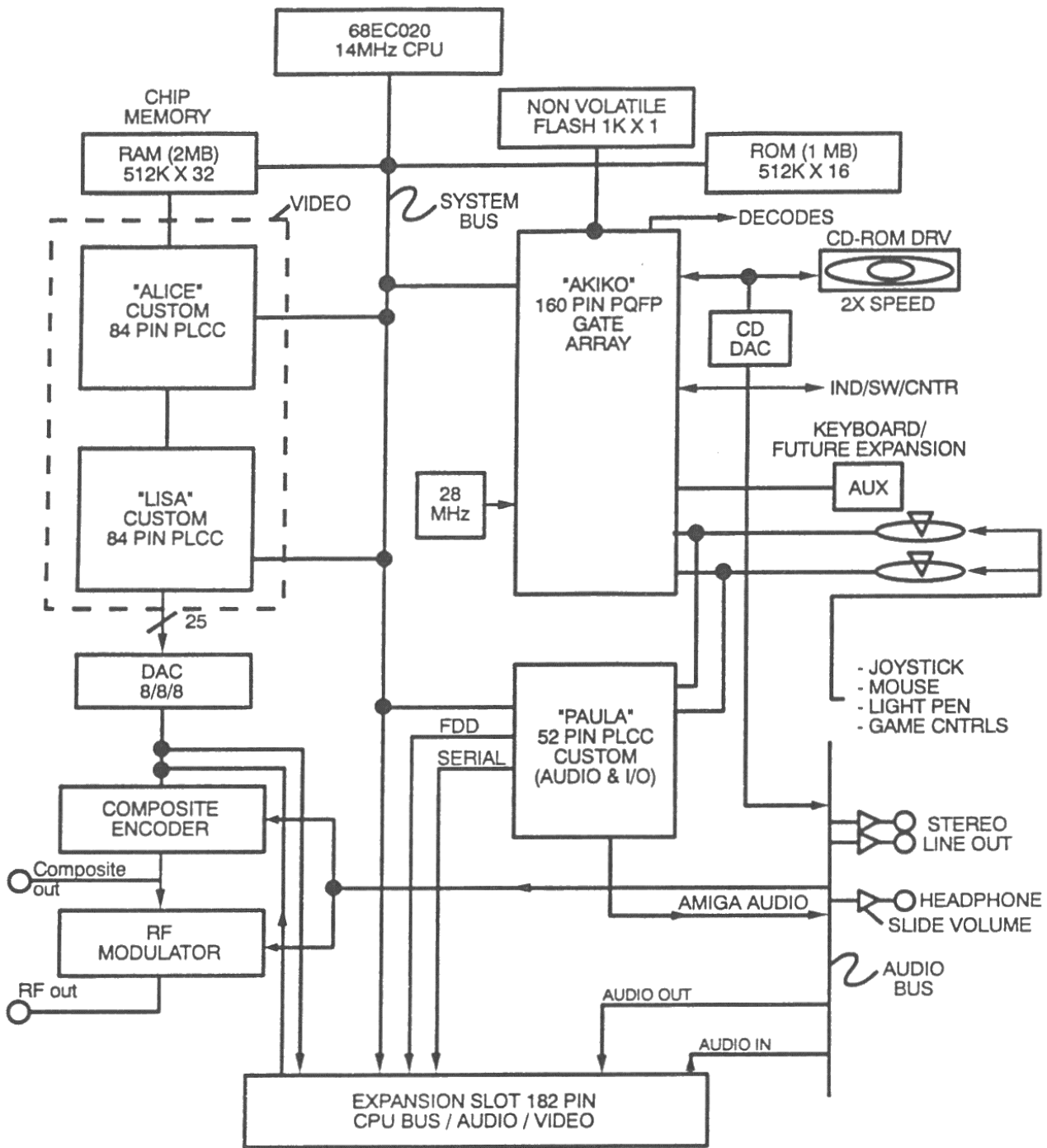

Figure 4-1. Amiga CD³² Block Diagram

System Memory Map

Address	Size	Waits	Function
\$000000-\$1FFFFE	32	Alice	Chip Ram (ROM after reset and before first 8520 access)
\$200000-\$A7FFFFE	16	0	AUTOCONFIG Space
\$A80000-\$B7FFFFE	16	0	ROM (Reserved)
\$B80000-\$B87FFFFE	32	0	Akiko Registers
\$B88000-\$BFFFFE	16	0	Reserved
\$B90000-\$B9FFFF	16	Alice	Amiga chip registers
\$BA0000-\$BDFFFFE	16	0	Reserved
\$BE0000-\$BEFFFFE	16	0	Reserved
\$BF0000-\$BFCCFE	16	8520	Illegal 8520 access/unsupported
\$BFDr00	16	8520	8520A legal decode for 8520 A register r
\$BFDr02-\$BFDrFC	16	8520	Illegal space that may or may not hit 8520A
\$BFDrFE	16	8520	8520A legal decode for 8520 A register r
\$BFEr00	16	8520	8520B legal decode for 8520 B register r
\$BFEr02-\$BFDrFC	16	8520	Illegal space that may or may not hit 8520B
\$BFErFE	16	8520	8520B legal decode for 8520 B register r
\$BFF000-\$BFFFFE	16	8520	Illegal 8520 access/unsupported
\$C00000-\$CFFFFE	16	Alice	Illegal (Hits RGAs for compatibility with old ROMs)
\$D00000-\$DEFFFFE	16	0	Reserved
\$DF0000-\$DFFFFE	16	Alice	RGA The one true location for Amiga chips
\$E00000-\$E7FFFF	16	0	ROM
\$E80000-\$F7FFFFE	16	0	Reserved
\$F80000-\$FFFFFE	16	0	ROM

External Connector Pinouts

Video Connector Pinout

RF Modulator Jack



Pin	Signal Name	Pin	Signal Name
Outside	Ground	Inside	Signal

S-video Port (4-pin mini-DIN)



	Signal Name	Pin	
1	Ground	3	Luminance
2	Ground	4	Chrominance

Color Composite Video (RCA Jack)



Pin	Signal Name	Pin	Signal Name
Outside	Ground	Inside	Composite Video Out

Audio Ports

Stereo Audio Ports

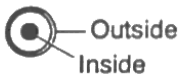

Audio Left (RCA Jack)

Audio Right (RCA Jack)

Pin	Signal Name	Pin	
Outside	Ground	Outside	Ground
Inside	Left Audio Channel	Inside	Right Audio Channel

Headphone Jack

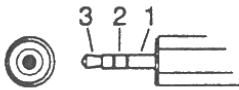

Pin	Signal Name	Pin	Signal Name
1	Ground (second ring)	3	Left audio (tip)
2	Right audio (first ring)		

Expansion Connector Pinouts

Game Ports 1 and 2

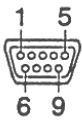

Pin	Signal Name	Pin	Signal Name
1	Mouse V	6	Mouse button 1
2	Mouse H	7	+5v (100 mA Max)
3	Mouse VQ	8	Ground
4	Mouse HQ	9	Mouse button 3 (POTY)
5	Mouse button 2 (POTX)		

Auxiliary Serial/Keyboard Port (6-pin mini-DIN)



Pin	Signal Name	Pin	Signal Name
1	Keyboard data	4	VCC (+5v)
2	Transmit data (serial)	5	Keyboard clock
3	Ground	6	Receive data (serial)

Power Connector (4-pin DIN)

Pin	Signal Name	Pin	Signal Name
1	VCC (+5v)	3	Not connected
2	Ground	4	+12v

Expansion Connector

The expansion connector has gold fingers (15- μ m minimum) with a pitch of 0.050 and mates with a number 650092-01 182-pin AMP connector.

Pin	Signal	Descriptions
Pin 1	A31	Processor Address Bus
Pin 2	A30	Processor Address Bus
Pin 3	A29	Processor Address Bus
Pin 4	A28	Processor Address Bus
Pin 5	A27	Processor Address Bus
Pin 6	A26	Processor Address Bus
Pin 7	A25	Processor Address Bus
Pin 8	A24	Processor Address Bus
Pin 9	DGND	Ground
Pin 10	VCC	Power
Pin 11	A23	Processor Address Bus
Pin 12	A22	Processor Address Bus
Pin 13	A21	Processor Address Bus
Pin 14	A20	Processor Address Bus
Pin 15	A19	Processor Address Bus
Pin 16	A18	Processor Address Bus
Pin 17	A17	Processor Address Bus
Pin 18	A16	Processor Address Bus
Pin 19	DGND	Ground
Pin 20	VCC	Power
Pin 21	A15	Processor Address Bus
Pin 22	A14	Processor Address Bus
Pin 23	A13	Processor Address Bus
Pin 24	A12	Processor Address Bus
Pin 25	A11	Processor Address Bus
Pin 26	A10	Processor Address Bus
Pin 27	A9	Processor Address Bus
Pin 28	A8	Processor Address Bus

Pin (con't)	Signal (con't)	Descriptions (con't)
Pin 29	DGND	Ground
Pin 30	VCC	Power
Pin 31	A7	Processor Address Bus
Pin 32	A6	Processor Address Bus
Pin 33	A5	Processor Address Bus
Pin 34	A4	Processor Address Bus
Pin 35	A3	Processor Address Bus
Pin 36	A2	Processor Address Bus
Pin 37	A1	Processor Address Bus
Pin 38	A0	Processor Address Bus
Pin 39	DGND	Ground
Pin 40	VCC	Power
Pin 41	D31	Processor Data Bus
Pin 42	D30	Processor Data Bus
Pin 43	D29	Processor Data Bus
Pin 44	D28	Processor Data Bus
Pin 45	D27	Processor Data Bus
Pin 46	D27	Processor Data Bus
Pin 47	D25	Processor Data Bus
Pin 48	D24	Processor Data Bus
Pin 49	DGND	Ground
Pin 50	VCC	Power
Pin 51	D23	Processor Data Bus
Pin 52	D22	Processor Data Bus
Pin 53	D21	Processor Data Bus
Pin 54	D20	Processor Data Bus
Pin 55	D19	Processor Data Bus
Pin 56	D18	Processor Data Bus
Pin 57	D17	Processor Data Bus
Pin 58	D16	Processor Data Bus
Pin 59	DGND	Ground
Pin 60	VCC	Power
Pin 61	D15	Processor Data Bus
Pin 62	D14	Processor Data Bus
Pin 63	D13	Processor Data Bus
Pin 64	D12	Processor Data Bus
Pin 65	D11	Processor Data Bus
Pin 66	D10	Processor Data Bus
Pin 67	D9	Processor Data Bus
Pin 68	D8	Processor Data Bus
Pin 69	DGND	Ground

Pin (con't)	Signal (con't)	Descriptions (con't)
Pin 70	VCC	Power
Pin 71	D7	Processor Data Bus
Pin 72	D6	Processor Data Bus
Pin 73	D5	Processor Data Bus
Pin 74	D4	Processor Data Bus
Pin 75	D3	Processor Data Bus
Pin 76	D2	Processor Data Bus
Pin 77	D1	Processor Data Bus
Pin 78	D0	Processor Data Bus
Pin 79	DGND	Ground
Pin 80	VCC	Power
Pin 81	_IPL2	Interrupt Priority Level
Pin 82	_IPL1	Interrupt Priority Level
Pin 83	_IPL0	Interrupt Priority Level
Pin 84	_IPEND	Interrupt Pending
Pin 85	_RST	Request to Send (RS232 Port)
Pin 86	_HLT	Processor Halt
Pin 87	_ECS	68030 ECS (reserved)
Pin 88	_OCS	68030 OCS (reserved)
Pin 89	SIZE_1	Processor Data Transfer Size
Pin 90	SIZE_2	Processor Data Transfer Size
Pin 91	_AS	Address Strobe
Pin 92	_DS	Data Strobe
Pin 93	R_W	Processor Read/Write
Pin 94	_BEER	Bus Error
Pin 95	_STERM	68030 STERM (reserved)
Pin 96	_AVEC	Interrupt Auto Vector
Pin 97	_DSACK_1	Data Transfer Vector
Pin 98	_DSACK_0	Data Transfer Vector
Pin 99	CPUCLK_A	CPU Clock 14 MHz
Pin 100	E	Peripheral Enable Clock
Pin 101	DGND	Ground
Pin 102	VCC	Power
Pin 103	FC2	Function Code
Pin 104	FC1	Function Code
Pin 105	FC0	Function Code
Pin 106	_RMC	Read Modify Cycle
Pin 107	_CIIN	68030 CIIN (Reserved)
Pin 108	_CIOUT	68030 CIOUT (Reserved)
Pin 109	_CBREQ	68030 CBREQ (Reserved)
Pin 110	_CBACK	68030 CBACK (Reserved)

Pin (con't)	Signal (con't)	Descriptions (con't)
Pin 111	_CPU_BR	CPU Bus Request
Pin 112	_EXP_BG	Expansion Bus Grant
Pin 113	_CPU_BG	CPU Bus Grant
Pin 114	_EXP_BR	Expansion Bus Request
Pin 115	_CPU_BGACK	CPU Bus Grant Acknowledge
Pin 116	_EXP_BGACK	Expansion Bus Grant Acknowledge
Pin 117	_PUNT	Back Off Signal to Console
Pin 118	_RESET	General Reset
Pin 119	_INT2	Interrupt Request (Chips)
Pin 120	_INT6	Interrupt Request (Chips)
Pin 121	_KB_CLOCK	Keyboard Clock (Keyboard)
Pin 122	_KB_DATA	Keyboard Data (Keyboard)
Pin 123	_FIRE0	Fire Button I/O (Joysticks)
Pin 124	_FIRE1	Fire Button I/O (Joysticks)
Pin 125	_LED	Power On LED / Audio Filter Disable
Pin 126	_ACTIVE	CD Drive Active
Pin 127	_RXD	Receive Data (RS232 Port)
Pin 128	_TXD	Transmit Data (RS232 Port)
Pin 129	_DKRD	Disk Read Data (Floppy)
Pin 130	_DKWD	Disk Write Data (Floppy)
Pin 131	SYSTEM	(Reserved)
Pin 132	DKWE	Disk Write Enable (Floppy)
Pin 133	_CONFIG_OUT	Zorro Config Signal
Pin 134	_CONFIG_IN	Zorro Config Signal
Pin 135	DGND	Ground
Pin 136	+12V	Power
Pin 137	DGND	Ground
Pin 138	+12V	Power
Pin 139	17MHZ	CD-Drive/CD-DAC Clock
Pin 140	_EXT_AUDIO	External Audio Enable
Pin 141	DA_DATA	CD-Data Data
Pin 142	_MUTE	Audio Mute Signal
Pin 143	DA_LRCLK	CD-Data Left-Right Clock
Pin 144	DA_BCLK	CD-Data Bit Clock
Pin 145	DGND	Ground
Pin 146	VCC	Power
Pin 147	DR	Digital Video Red
Pin 148	DG	Digital Video Green
Pin 149	DB	Digital Video Blue
Pin 150	DI	Digital Video Intensity
Pin 151	_PIXELSW_EXT	External Genlock Pixel Swtich (Video)

Pin (con't)	Signal (con't)	Descriptions (con't)
Pin 152	_PIXELSW	Genlock Pixel Switch (Video)
Pin 153	_BLANK	Video Blanking Signal
Pin 154	PIXELCLK	Pixel Clock
Pin 155	DGND	Ground
Pin 156	VCC	Power
Pin 157	_CSYNC	Composite Sync (Video)
Pin 158	CCK_B	Color Clock
Pin 159	_HSYNC	Horizontal Sync (Video)
Pin 160	_VSYNC	Vertical Sync (Video)
Pin 161	DGND	Ground
Pin 162	DGND	Ground
Pin 163	AR_EXT	External Analog Red
Pin 164	AR	Analog Red
Pin 165	AG_EXT	External Analog Green
Pin 166	AG	Analog Green
Pin 167	AB_EXT	External Analog Blue
Pin 168	AB	Analog Blue
Pin 169	DGND	Ground
Pin 170	DGND	Ground
Pin 171	_NTSC	NTSC
Pin 172	_XCLKEN	External Clock Enable (Video)
Pin 173	XCLK	External Genlock Clock (Video)
Pin 174	_EXT_VIDEO	Enable External Video
Pin 175	DGND	Ground
Pin 176	VCC	Power
Pin 177	AGND	Power
Pin 178	+12V	Power
Pin 179	LEFT_EXT	External Audio Left
Pin 180	LEFT	Audio Left
Pin 181	RIGHT_EXT	External Audio Right
Pin 182	RIGHT	Audio Right

Akiko Specification

Akiko functions as the main control gate array for the Amiga CD³² Game System (CDGS). It acts as an interface between the processor and the custom chips buffering the data and generating the control signals. It also contains an interface for talking to a CD drive mechanism and a corner turn memory for accelerating Chunky to Planar pixel conversion. This device occupies position U5 in the CD game system.

Configuration

This device is configured as a 160-pin plastic quad flat pack (PQFP) package, with external dimensions as shown in Figure 4-2.

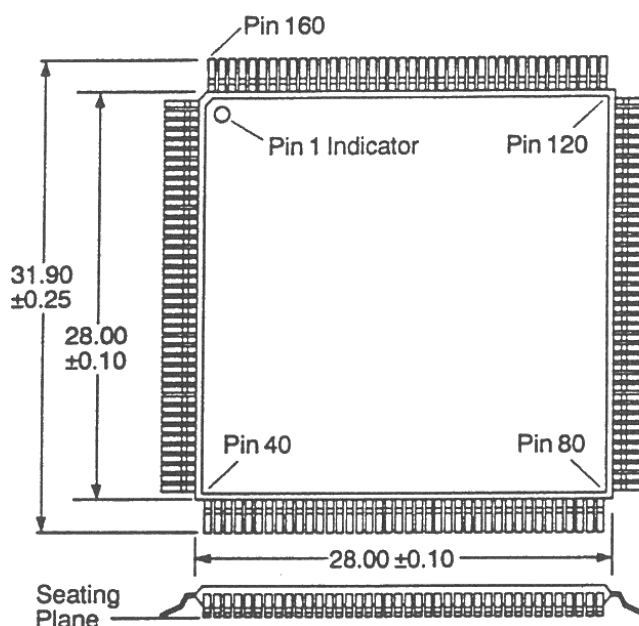

Figure 4-2. Akiko Dimensions and Pin Numbers

Sources

Refer to the Approved Vendor List (AVL).

Applicable Documents

Commodore Engineering Policy 1.02.007

Integrated Circuit Qualification Procedure

Commodore Engineering Policy 1.02.008

Integrated Circuit Process Test Specification

Pinouts

In the following table:

I = Input
O = Output
B = Bidirectional
P = Power

PIN #	NAME	TYPE	Description
1	VDDE1	P	Power
2	PD16	B	Processor Data
3	PD17	B	Processor Data
4	PD18	B	Processor Data
5	PD19	B	Processor Data
6	PD20	B	Processor Data
7	PD21	B	Processor Data
8	PD22	B	Processor Data
9	PD23	B	Processor Data
10	VSSE4	P	Power
11	PD24	B	Processor Data
12	PD25	B	Processor Data
13	PD26	B	Processor Data
14	PD27	B	Processor Data
15	PD28	B	Processor Data
16	PD29	B	Processor Data
17	PD30	B	Processor Data
18	PD31	B	Processor Data
19	VDDE3	P	Power
20	CD0	B	Custom Chip Data
21	CD16	B	Custom Chip Data
22	CD1	B	Custom Chip Data
23	CD17	B	Custom Chip Data
24	CD2	B	Custom Chip Data
25	CD18	B	Custom Chip Data
26	CD3	B	Custom Chip Data
27	CD19	B	Custom Chip Data
28	CD4	B	Custom Chip Data
29	CD20	B	Custom Chip Data
30	VSSE5	P	Power
31	CD5	B	Custom Chip Data
32	CD21	B	Custom Chip Data
33	CD6	B	Custom Chip Data

34	CD22	B	Custom Chip Data
----	------	---	------------------

PIN # (con't)	NAME (con't)	TYPE (con't)	Description (con't)
35	CD7	B	Custom Chip Data
36	CD23	B	Custom Chip Data
37	CD8	B	Custom Chip Data
38	CD24	B	Custom Chip Data
39	CD9	B	Custom Chip Data
40	CD25	B	Custom Chip Data
41	VSSI1	P	Power
42	CD10	B	Custom Chip Data
43	CD26	B	Custom Chip Data
44	VSSE1	P	Power
45	CD11	B	Custom Chip Data
46	CD27	B	Custom Chip Data
47	CD12	B	Custom Chip Data
48	CD28	B	Custom Chip Data
49	CD13	B	Custom Chip Data
50	CD29	B	Custom Chip Data
51	CD14	B	Custom Chip Data
52	CD30	B	Custom Chip Data
53	CD15	B	Custom Chip Data
54	CD31	B	Custom Chip Data
55	VDDI3	P	Power
56	RAS_	I	Processor Reset
57	AWE_	I	Alice Write Enable
58	SCANEN	I	Test Mode Enable
59	BCLK	I	CD Bit Clock
60	VSSE3	P	Power
61	CPUCLK	I	CPU Clock
62	VSSSI3	P	Power
63	BCAS_0	O	Buffered Cas Byte 0
64	BCAS_1	O	Buffered Cas Byte 1
65	CAS	I	Buffered Cas Byte from Alice
66	BCAS_2	O	Buffered Cas Byte 2
67	BCAS_3	O	Buffered Cas Byte 3
68	ADRA0	I	DRAM Address 0 from Alice
69	ADRA1	I	DRAM Address 1 from Alice
70	RDRA0	I	DRAM Address 0 to DRAM
71	RAMEN_	O	RAM Enable/Chip Memory Access
72	REGEN_	O	Register Enable/Chip Register Access

PIN # (con't)	NAME (con't)	TYPE (con't)	Signal Description (con't)
73	ROMEN_	O	ROM Enable
74	DBR_	I	Chip Data Bus Request
75	RWE_	O	DRAM Write Enable
76	IFCLK	I	CD Command Interface Clock
77	IFDAT	B	CD Command Interface Data
78	IFDIR	I	CD Command Interface Direction
79	LRCLK	I	CD Data Left/Right Clock
80	VDDI2	P	Power
81	VDDE2	P	Power
82	DATA	I	CD-Data Data
83	C2PO	I	CD-Data Errors
84	INT2_	O	Interrupt Request (Chips)
85	INT3_	I	Interrupt Request (Chips)
86	INT6_	O	Interrupt Request (Chips)
87	BLS_	O	Blitter Slow Down
88	SCOR	I	CD-Subcode Sync
89	SUBCL	O	CD-Subcode Clock
90	SUBDAT	I	CD-Subcode Data
91	WFCLK	I	CD-Subcode Frame Clock
92	LED_	B	Power On LED / Audio Filter Disable
93	MUTE	B	Audio Mute Signal
94	VSSE8	P	Power
95	FIRE0	B	Fire Button
96	FIRE1	B	Fire Button
97	KBCLK	B	Keyboard Clock (Keyboard)
98	KBDATA	B	Keyboard Data (Keyboard)
99	IOP0	B	General Purpose I/O Pin 0
100	IOP1	B	General Purpose I/O Pin 1
101	BR_	O	Bus Request
102	BG_	I	Bus Grant
103	VDDE5	P	Power
104	BERR_	O	Bus Errors
105	AS_	B	Address Strobe
106	DS_	B	Data Strobe
107	RW_	B	Processor Read/Write
108	SZ0	B	Data Transfer Size
109	SZ1	B	Data Transfer Size
110	DSACK0_	B	Data Transfer Termination
111	DSACK1_	B	Data Transfer Termination

PIN # (con't)	NAME (con't)	TYPE (con't)	Signal Description (con't)
112	VSSE2	P	Power
113	A23	B	Processor Address Bus
114	A22	B	Processor Address Bus
115	A21	B	Processor Address Bus
116	A20	B	Processor Address Bus
117	A19	B	Processor Address Bus
118	A18	B	Processor Address Bus
119	A17	B	Processor Address Bus
120	A16	B	Processor Address Bus
121	VSSI2	P	Power
122	EXTACC_	I	Processor Address Bus
123	A15	B	Processor Address Bus
124	A14	B	Processor Address Bus
125	A13	B	Processor Address Bus
126	A12	B	Processor Address Bus
127	A11	B	Processor Address Bus
128	A10	B	Processor Address Bus
129	A9	B	Processor Address Bus
130	A8	B	Processor Address Bus
131	VSSE7	P	Power
132	A7	B	Processor Address Bus
133	A6	B	Processor Address Bus
134	A5	B	Processor Address Bus
135	A4	B	Processor Address Bus
136	A3	B	Processor Address Bus
137	A2	B	Processor Address Bus
138	A1	B	Processor Address Bus
139	A0	B	Processor Address Bus
140	VDDE4	P	Power
141	PD0	B	Processor Data
142	PD1	B	Processor Data
143	PD2	B	Processor Data
144	PD3	B	Processor Data
145	PD4	B	Processor Data
146	PD5	B	Processor Data
147	PD6	B	Processor Data
148	PD7	B	Processor Data
149	VSSE6	P	Power
150	PD8	B	Processor Data

PIN # (con't)	NAME (con't)	TYPE (con't)	Signal Description (con't)
151	PD9	B	Processor Data
152	PD10	B	Processor Data
153	PD11	B	Processor Data
154	PD12	B	Processor Data
155	PD13	B	Processor Data
156	PD14	B	Processor Data
157	PD15	B	Processor Data
158	CPU_	I	CPU Space Cycle (F.P.U)
159	RESET_	B	General Reset
160	VDDI2	P	Power

PHYSICAL REQUIREMENTS

Marking

The parts are marked with Manufacturer's Part Number, Manufacturer's Identification, and EIA Date Code.

Packaging

A 160-pin PQFP plastic package with exterior dimensions illustrated in Figure 4-2 contains the interconnected logic circuitry.

Minimum Acceptance Level

The minimum acceptance level of any lot is an AQL of 0.65 as defined by MIL-STD 105 single sampling techniques.

Age Of Devices

Reject any unit with a EIA Date Code indicating an age of three (3) or more years.

Chapter 5

Bill of Materials

The following information is taken from the Amiga CD³² Bill of Materials (BOM).

- Title of the drawing
- Number and revision level of the drawing
- Part number of each part
- Description of each part
- Reference description/notes for each part

The BOM contains additional product configuration data not reproduced in this table. The BOM is updated periodically. For a complete current listing of all the information contained in a BOM (including line item numbers), request the latest revision BOM drawings (by drawing number) from Engineering Documentation in West Chester.

Bracket	Description
[]	National Television Standard Committee (NTSC) US television standard
()	Phase Alternation Line (PAL) European television standard
{ }	Notes

PCB Assembly, CD Game System (365101 Rev D)

365101-01	PCB Assembly, CD Game System, NTSC	
365101-02	PCB Assembly, CD Game System, PAL	
365100-01	Schematic, CD Game System	
365103-01	PCB Fab, CD Game System	
365102-01	Functional Spec, CD Game System	
365104-01	Artwork, CD Game System	
	INTEGRATED CIRCUITS	
391506-01	IC, CPU, MC68EC020, 16 mHz, 100-Pin PQFP	U1
391010-01	IC, 8374, ALICE, 84-Pin PLCC	U2
391227-01	IC, 4203, LISA, 84-Pin PLCC	U4
391077-01	IC, 8364R7, PAULA, 52-Pin PLCC	U3
391563-01	IC, GATE ARRAY, Akiko, 160-Pin PQFP	U5
391624-01	IC, 74F00, SM, EIAJ	U25; Substitute for PN 391139-01
391547-01	IC, 74LS166, SM, EIAJ	U34; Substitute for PN 391426-01
391655-01	IC, 74F373, SM, EIAJ	U35; Substitute for PN 391376-01
391548-01	IC, 74F86, SM, EIAJ	U37; Substitute for PN 391325-01
391139-01	IC, 74F00, SM	U25
391426-01	IC, 74LS166, SM	U34
391376-01	IC, 74F373, SM	U35

PCB Assembly, CD Game System (365101 Rev D) **(cont'd)**

391325-01	IC, 74F86, SM	U37
391141-01	IC, SM, 74LS74A	U33
391311-01	IC, 74HC4066, SM	U22, U36
391283-02	IC, Voltage Detector, RH5VA43A, SM	U14, U49
391599-02	IC, DRAM, 512Kx8, 80ns, SM	U16-U19
391640-01	IC, ROM, Kickstart, CDGS, 512kx16, 42-Pin DIP	U6
391084-01	IC, Video Encoder, CXA1145M, SM	U12
391422-01	IC, Video DAC, BT101, 44-Pin PLCC	U30
391638-01	IC, EPROM, Kickstart, CDGS, 512Kx16, 42-Pin DIP	U6; Programmed into 391639-01
391422-02	IC, Video DAC, BT101, 44-Pin PLCC	U30; Substitute for PN 391422-01 (Do not stuff D215 & R215)
391633-01	IC, DAC, Audio, LC78835M, SM	U31
391632-01	IC, SM, Dual Op Amp, TL082/LF353	U15A, U15B, U38B
391630-01	IC, Amp, Headphone, CXA1263AM, SM	U39
391631-01	IC, Linear, LM358, SM	U38A
391262-01	Voltage Regulator, 78L05, SM	U32
391635-03	IC, EEPROM, 24C08, SM	U9
391555-01	IC, SM, 74LS74A, EIAJ	U33; Substitute for PN 391141-01
391644-01	IC, 74HC4066, SM, EIAJ	U22, U36; Substitute for PN 391311-01
391656-01	IC, SM, Dual Op Amp, TL082/LF353, EIAJ	U15A, U15B, U38B; Substitute for PN 391632-01
CONNECTORS		
390242-01	D-SUB, 9-Pin, Male, DB9P	CN1, CN2 {Mouse/Joystick}
252122-03	RCA Jack, Yellow	CN10 {Composite Video}
252122-01	RCA Jack, White	CN4 {Left Audio}
252122-02	RCA Jack, Red	CN3 {Right Audio}
390272-01	DIN, 4-Pin, Round, Shielded	CN8 {CPU Power}
391648-01	Connector, Header, 10-Pin, 2.0mm, R-ANG.	CN14
390543-03	Connector, FPC, Vertical, 26-Pin	CN17 (CD ROM)
390851-02	Mini-DIN, 4-Pin, Round	CN9 {S-Video}
390851-04	Mini-DIN, 6-Pin, Round	CN13 {Keyboard}
TRANSISTORS		
391705-01	Transistor, JFET, MMBF5484L, SOT23	Q321, Q331
391121-01	Transistor, NPN, 2N3904, SOT23	Q201, Q281, Q282, Q346, (Q461), Q751, Q752, Q855, Q856, Q766, Q395, Q396
391122-01	Transistor, PNP, 2N3906, SOT23	Q341, Q342, Q632, Q633
391393-01	Transistor, SM, MOSFET, MMBF170, SOT23	Q355, Q356, Q365, Q366
391701-01	Transistor, SM, MOSFET, P-Channel, S194OODY	Q765
391702-01	Transistor, MOSFET, P-Channel, 1RFD9020	Q765A (Substitute for PN 371701-01)
DIODES		
391561-02	Diode, ZENER. 6.3V, SOT23	D891
391129-01	Diode, 1N4148, SOT23	D281, D355, D356, D366, D365, D629
391128-01	Diode, 1N914, SOT23	Substitute for PN 391129-01
391327-01	Diode, SM, 1N4001, MELF PKG	D32, D641-D644

PCB Assembly, CD Game System (365101 Rev D)

(cont'd)

391421-01	Voltage Reference, LM385, SO-8	D215 (Do not stuff when using 391422-02)
391531-01	LM4041, Voltage Reference, 1.2V, SOT-23	D215A Substitute for 391421-01 (Do not stuff when using 391422-02)
FILTERS		
391092-03	Filter, Ferrite, SM, (1206)	E321R, E331R, E351R, E361R, E353R, E358R, E363R, E368R, E325R
391092-01	Filter, Ferrite, SM, Large, (1812)	FB301A, FB401A, FB401B, FB402A, FB402B, FB641, FB750
391092-02	Filter, Ferrite, SM, Medium, (1206)	E231R, E281R, E282R, E622R, E623R, E626R, E627R, FB131, FB133, FB621-FB623, FB751, FB992
391138-02	Inductor, SM, 2.7uH, (1206)	L751
391138-01	Inductor, SM, 1.2uH, (1206)	(L241)
391146-02	Bandpass Filter, F-K5-MS	[Z221]
391147-02	Delay Line, F-K5-MD	(Z222)
391146-01	Bandpass Filter, BPF-K5-MS	(Z221)
391147-01	Delay Line, F-KS-MT	(Z222)
390253-04	Ferrite Bead, 2.5 Turn	LF1A-C
CAPACITORS		
390818-03	Cap, SM, NPO, 15PF, (1206)	(C242)
390818-01	Cap, SM, NPO, 22PF, (1206)	E112C, E120C-E122C, (E124C), E127C, E129C, E375C-E377C, E643, E644, E762C
390818-07	Cap, SM, NPO, 33PF, (1206)	C751
390818-05	Cap, SM, NPO, 56PF, (1206)	(C241), C245
390818-06	Cap, SM, NPO, 100PF, (1206)	E231C, E281C, E282C, E621C-E627C, E641C, E642C
390818-08	Cap, SM, NPO, 120PF, (1206)	C772, C782
390853-06	Cap, SM, X7R, 470PF, (1206)	E351C, E353C, E354C, E361C, E363C, E364C, E374C
390853-07	Cap, SM, X7R, 1000PF, (1206)	(C243), C282, C460, C771, C781
390853-08	Cap, SM, X7R, 3900PF, (1206)	C323, C333
390853-09	Cap, SM, X7R, 6800PF, (1206)	C321, C322, C331, C332, E321C, E331C, E355C-E358C, E365C-E368C
390853-01	Cap, SM, X7R, .01UF, (1206)	C216, (C244), C246, C349, C800-C802
390853-04	Cap, SM, X7R, .047UF (1206)	C1B, C1D, C5B, C5D, C9, C12B, C25, C30A, C30B, (C33), C34, C37, C311-C314, C806
310027-02	Cap, SM, Z5U, .1UF, (1206)	C221, C222, C355, C365, E232C
390797-02	Cap, SM, CERM, SL/B/V, .22UF	C1A, C1C, C2A, C2B, C3, C4A, C4B, C5A, C5C, C6A, C6B, C12A, C15A, C15B, C16A, C16B, C17A, C17B, C18A, C18B, C19A, C19B, C22, C32, C35, C36, C38A, C38B, C39, C199, C211A-C211C, C217, C305, C352, C362, C641, C750, C761, C762, C804, C805, C881, C893
391637-02	Cap, SM, Elect. 4.7uF, Audio	C777, C787, C855, C865
390797-01	Cap, SM, CERM, SL/B/V, .33UF	C2X
310027-06	Cap, SM, Z5U, .47UF, (1206)	C31, C30C, C30D, C629

PCB Assembly, CD Game System (365101 Rev D)

(cont'd)

391231-13	Cap, SM, Tantalum, 10UF 16V, (C)	C407
391097-07	Cap, SM, Elect Alum, 10UF 25V, (C)	C214, C341, C791, C792
391097-08	Cap, SM, Elect Alum, 22UF 25V, (C)	C303, C459
391097-04	Cap, SM, Elect Alum, 47UF 16V, (D)	C235, C236, C885, C891, C892
391097-01	Cap, SM, Elect Alum, 100UF 6.3V, (D)	C237, C239, C409, C890, C281, C307, C790, C854, C864
390101-12	Cap, Elect Alum, 470UF, 10V	C821
390101-10	Cap, Elect Alum, 1000UF, 10V	C408, C811
RESISTORS 1/8W 5%		
310026-01	Resistor, SM, 47 Ohm (1206)	R155, R156, R371
310026-26	Resistor, SM, 0 Ohm (1206)	[R203], [R225], R801, R802
310026-24	Resistor, SM, 120 Ohm (1206)	R236
310026-42	Resistor, SM, 180 Ohm (1206)	(R236) R639
310026-10	Resistor, SM, 27 Ohm (1206)	E120R-E122R, E127R, E129R, E376R, E377R, E641R, E642R, R113-R115, R597, R598, E112R, E123R, E125R, R264
310026-12	Resistor, SM, 68 Ohm (1206)	(E124R), E131R-E134R, E374R, E375R, E751R, E752R, R151A-J, R152B-G, R239A-F, R261A-H, R262A-H, R263A-H, R265, R285, E621R, E624R, E643, E644, E761R, E762R, E753R
310026-05	Resistor, SM, 100 Ohm (1206)	R237, R282, R284
310026-14	Resistor, SM, 360 Ohm (1206)	R235
310026-56	Resistor, SM, 680 Ohm (1206)	R892
310026-25	Resistor, SM, 1.5K Ohm (1206)	R768
310026-21	Resistor, SM, 470 Ohm (1206)	R109, R324, R334, R341, R379, R593, R952A, R952B, R953A-F, R217, R751, R750
310026-11	Resistor, SM, 820 Ohm (1206)	R224, (R221)
310026-07	Resistor, SM, 1K Ohm (1206)	R101, R102, R104, R141, R142, R215, R222, [R221], (R244), R319, R511A, R511B, R633, R635, R643, R644, R881, R951A, R951B, R954A-E, R766, R853, R863 (Do not stuff when using 391422- 02)
310026-29	Resistor, SM, 75 Ohm (1206)	R232E, R234, R283
310026-16	Resistor, SM, 2.7K Ohm (1206)	(R245), [R246]
310026-08	Resistor, SM, 4.7K Ohm (1206)	R105, R153, R154, R202, R204, R219, (R241), R250-R253, R340, R342, R347, R348, R370A-R370H, R391, R392, R397, R398, R634, R636, R752, R754, R756, R763A-R763H, R771, R772, R775, R781, R782, R855, R865, R951C-G, R954F, R954G, R397, R398
310026-35	Resistor, SM, 6.8K Ohm (1206)	(R242), R767, R779, R789
310026-64	Resistor, SM, 8.2K Ohm (1206)	R851, R861
310026-50	Resistor, SM, 18K Ohm (1206)	R773, R776, R779, R789
310026-17	Resistor, SM, 10K Ohm (1206)	R209, (R243), R322, R323, R332, R333, R628, R629, R760, R761, R762, R770
310026-42	Resistor, SM, 180 Ohm, (1206)	R639

PCB Assembly, CD Game System (365101 Rev D)

(cont'd)

310026-38	Resistor, SM, 2.2K Ohm (1206)	R281
310026-22	Resistor, SM, 330 Ohm (1206)	R320, R321, R330, R331
310026-23	Resistor, SM, 22K Ohm (1206)	R778, R788
310026-18	Resistor, SM, 33K Ohm (1206)	R349, R774, R784
310026-03	Resistor, SM, 47K Ohm (1206)	R344, R753, R755, R395, R396
310026-31	Resistor, SM, 100K Ohm (1206)	R345, R777, R787, R856, R866
310026-19	Resistor, SM, 470K Ohm (1206)	R326, R336
310026-53	Resistor, SM, 10M Ohm (1206)	R355, R365
310026-62	Resistor, SM, 82K Ohm (1206)	R327, R337
RESISTORS 1/8W,1%		
391154-13	Resistor, SM, 1/8W, 1%, 15 Ohm (1206)	R216
391154-14	Resistor, SM, 1/8W, 1%, 24.9 Ohm (1206)	R232A-R232C
391154-12	Resistor, SM, 1/8W, 1%, 49.9 Ohm (1206)	R231A-R231C
391154-42	Resistor, SM, 1/8W, 1%, 866 Ohm (1206)	[R223]
391154-03	Resistor, SM, 1/8W, 1%, 1K Ohm (1206)	R303, R304, R892
391154-39	Resistor, SM, 1/8W, 1%, 27 hm (1206)	R459
391154-43	Resistor, SM, 1/8W, 1%, 698 Ohm (1206)	(R223)
RESISTORS 1/8W,5%		
391093-01	Resistor, SM, 1W, 5%, 1 Ohm (2512)	R309
391093-02	Resistor, SM, 1W, 5%, 4.7 Ohm (2512)	E232R, R352, R362
391154-39	Resistor, SM, 1/8W, 1%, 27K Ohm (1206)	R459
310026-50	Resistor, SM, 1/8W, 5%, 18K Ohm (1206)	R773, R776, R783, R786
MISCELLANEOUS		
252182-01	Switch, Rocker, DPDT, R-Angle, PC-MT	SW1
252182-02	Switch, Rocker, DPDT, R-Angle, PC-MT	Substitute for PN 252182-01
252345-01	Crystal, 4.433619 MHz	(Y451)
325566-14	Oscillator, 28.63636 MHz	[X1]
252344-01	Oscillator, 28.37516 MHz	(X1)
391693-01	Oscillator, 16.9344 MHz	X3
313371-01	Modulator, MDG-VA3424	[X2]
313371-05	Modulator, MDG-UD3626	(X2)
904500-02	Switch, Rocker, DPDT, R-Ang, PC-MT	SW1; Substitute for PN 252182-01

Main Assembly/CDGS Player (365158 Rev C)

365158-01	Main Assembly: PAL/CDGS Player	
365158-02	Main Assembly: NTSC/CDGS Player	
365160-01	Top Assembly/CDGS Player	
365159-01	Bottom Assembly: PAL/CDGS Player	
365159-02	Bottom Assembly: NTSC/CDGS Player	
390146-01	Screw, Torx Drive, Hi-Lo Flute, M3 x 8.0 LG	
390177-02	Screw, Torx Drive, Tri-Lobe	Substitute for PN 390146-01
369651-01	Label, Laser Caution	
906810-19	Screw, Machine, M4 x 0.7 x 12.0 LG	
365306-01	Nut, Speed, 'U' Type, M4 x 0.7	

Bottom Assembly: CDGS Player (365159 Rev B)

365159-01	Bottom Assembly: PAL/CDGS Player
365159-02	Bottom Assembly: NTSC/CDGS Player
365101-02	PCB Assembly: PAL/CDGS Player
365101-01	PCB Assembly: NTSC/CDGS Player
365167-01	Shield, Top
365166-01	Shield, Bottom
365216-01	Insulation Sheet
313376-03	Cable, Flexible Flat
365195-01	Bottom Case
310080-02	Foot, Rubber, Black

Bottom Assembly: CDGS Player (365159 Rev B)**(cont'd)**

369652-01	Label, Laser Date	
369630-02	Rating Label/VDE	Made in Phillipines
369630-01	Rating Label/FCC	Made in Phillipines
369630-01	Rating Label/Brazil	Used for Brazil only
390146-01	Screw, Torx Drive, Blunt Pnt, ST, Hi-Lo Flute	
390177-01	Screw, Torx Drive, Tri-Lobe	Substitute for PN 390146-01
365367-01	Cable, LED	
365367-02	Cable, LED with Torroid (1 turn)	
365193-01	Cover, Expansion	

Top Assembly/CDGS Player (365160 Rev A)

365160-01	Top Assembly/CDGS Player	
365161-01	CD ROM Drive Assembly	
365169-01	Lid Assembly	
365172-01	Hinge Mechanism Assembly	
365171-01	Hinge Pin	
365196-01	Top Case	
365168-01	LED PCB Assembly CDGS/P	
365219-01	Button, Reset	
365218-01	Button, Volume	
365282-01	Spring	Use with PN 365219-01
365301-01	Nameplate, CDGS (Amiga CD32)	
365012-03	Screw, Flat Head, Mach., M2 x 6.0 LG	Hinge Mechanism (Black)
390146-01	Screw, Torx T-10 Drive, M3 x 8.0mm, PH	LED PCB Assy/Drive Mech.
906921-03	Screw, Flat Head, Self Tap., M2.5 x 4.0 LG	(Black) for PN 365171-01
906803-07	Screw, Flat Head, Mach., M3 x 5 LG	(Black)
390177-02	Screw, Torx Drive, Tri-Lobe	Substitute for PN 390146-01
390177-01	Screw, Torx Drive, Tri-Lobe	Substitute for PN 390146-01
365366-01	Lubricant, Lithium	For PN 365172-01, Hinge Mechanism

CD ROM Drive Assembly/CDGS Player (365161 Rev A)

365161-01	CD ROM Drive Assembly
365181-01	CD ROM Mechanism
365194-01	Mounting Plate
365180-01	Insulator- "K" Type

CD ROM Drive Assembly/CDGS Player (365161 Rev A) (cont'd)

365179-01	U-Spring, Front, (Silver, Light)	Spring 'B'
365178-01	U-Spring, Rear, (Gold, Heavy)	Spring 'A,' Motor Side
365177-01	Controller PCB Assembly	
365176-01	Cable, Head Mechanism	
365176-02	Cable, Head Mechanism	
365175-01	Cable, Drive	
365174-01	Spindle/Lens Cover	
365173-01	Shield, Controller PCB	
365197-01	Screw, Shoulder	Used with PN 365180-01, 365179-01, 365178-01
365224-01	Standoff, Hex, Female/Male, M3 x 11	
365236-01	Screw, Pan HD, Self Tap, M2 x 5 LG AB	For mounting PN 365174-01
390146-04	Torx T-10 Drive M3 x 5mm, PH	For mounting PN 365177-01, 365173-01, 905655-03 and 365223-01
905655-03	Washer, External Tooth Lock, M3	
365223-01	Insulation Sheet	
390177-04	Screw, Torx Drive, Tri-Lobe	Substitute for PN 390146-04

Disk Chucking Assembly/CDGS Player (365163 Rev A)

365163-01	Disk Chucking Assembly
365191-01	Magnet
365190-01	Chucking Plate "A"
365189-01	Washer 80 x 45 x .5
365188-01	Chucking Plate "B"
365230-01	Screw, M2 x 3.0, Mach.

PCBA, CDGS, LED/Audio (365168 Rev B)

365168-01	PCB Assembly, CDGS, LED/Audio	
365229-01	Schematic, CDGS, LED/Audio PCB	
365228-01	PCB Fab, CDGS, LED/Audio PCB	
365227-01	Artwork, CDGS, LED/Audio PCB	
391636-01	Switch, DPDT, Pushbutton, Vert	SW1
391634-01	POT, 50K, Single, Slide, Audio	VR1
391649-01	Headphone Jack, Stereo, 3.5mm, Vert	J1
252018-02	LED, 2 x 15mm, Green	D2
252018-05	LED, 2 x 15mm, Yellow	D1
365373-01	Spacer, LED	
390904-03	Resistor, 1/4W, 5%, 22 Ohm, 5mm	R1, R2
391648-01	Header Assy, R-Ang, 2.0mm, 10 Pos	P1
390904-26	Resistor, Carbon Film, 1/4W, 5%, 33K Ohm	R5
390904-18	Resistor, Carbon Film, 1/4W, 5%, 10K Ohm	R4
390904-32	Resistor, Carbon Film, 1/4W, 5%, 180 Ohm	R3
901550-63	Resistor, Carbon Film, 1/4W, 5%, 22 Ohm	Substitute for PN 390904-03
901550-06	Resistor, Carbon Film, 1/4W, 5%, 33K Ohm	Substitute for PN 390904-26
901550-20	Resistor, Carbon Film, 1/4W, 5%, 10K Ohm	Substitute for PN 390904-18

PCBA, CDGS, LED/Audio (365168 Rev B) (cont'd)

901550-100	Resistor, Carbon Film, 1/4W, 5%, 180 Ohm	Substitute for PN 390904-32
390082-05	Capacitor, Ceramic, Axial, .22uF, 50V	C1
391670-01	Phototransistor, IR, Side Looking	Q1
391672-01	LED, IR, Side Emitting	D3

Cable, LED (365367 Rev B)

365367-01	Cable Assembly, CDGS, LED	
365367-02	Cable Assembly, CDGS, LED, with Ferrite Torroid, 1 Turn	
365367-03	Cable Assembly, CDGS, LED, with Ferrite Torroid, 2 Turns	
200016-113	Wire, Lead, 26 AWG, Black, Standard, 350mm	1.6mm-2.1mm Strip Length
200016-114	Wire, Lead, 26 AWG, Black, Standard, 400mm	1.6mm-2.1mm Strip Length
200016-115	Wire, Lead, 26 AWG, Black, Standard, 450mm	1.6mm-2.1mm Strip Length
391710-01	Crimp Terminal, 2mm Wire to Board	
391709-01	Housing, 10 Position, 2mm Wire to Board	
391708-01	Connector, 10-pin IDT, 2mm Wire to Board	Substitute for 391710-01 and 391709-01
906115-02	Torroid, Ferrite Ring	

Lid Assembly/CDGS Player (365169 Rev A)

365169-01	Lid Assembly
365170-01	Lid
365163-01	Disk Chucking Assembly
365234-02	Retaining Ring
365215-01	Viewing Window
365236-01	Screw, M2 x 5, Pan Head, Self Tapping
365235-01	Stop, Rubber

Hinge Mechanism Assembly (365172 Rev A)

365172-01	Hinge Mechanism Assembly
365200-01	Spring, Lid
365201-01	Pivot Arm
365203-01	Base Pivot

Shipping Assembly CDGS Player (513515 Rev C)

513515-01	Shipping Assembly CDGS Player, US
513515-02	Shipping Assembly CDGS Player, CN
513515-03	Shipping Assembly CDGS Player, UK
513515-04	Shipping Assembly CDGS Player, GR
513515-05	Shipping Assembly CDGS Player, FR
513515-06	Shipping Assembly CDGS Player, IT
513515-07	Shipping Assembly CDGS Player, SP
513515-08	Shipping Assembly CDGS Player, SG
513515-09	Shipping Assembly CDGS Player, SF

Shipping Assembly CDGS Player (513515 Rev C)

(cont'd)

513515-10	Shipping Assembly CDGS Player, AU	
513515-11	Shipping Assembly CDGS Player, NR	
513515-12	Shipping Assembly CDGS Player, SD	
513515-13	Shipping Assembly CDGS Player, FN	
513515-14	Shipping Assembly CDGS Player, NE	
513515-15	Shipping Assembly CDGS Player, DN	
513515-16	Shipping Assembly CDGS Player, BF	
513515-17	Shipping Assembly CDGS Player, BD	
513515-18	Shipping Assembly CDGS Player, AL	
513515-19	Shipping Assembly CDGS Player, CEL	
513515-20	Shipping Assembly CDGS Player, PG	
513515-21	Shipping Assembly CDGS Player, JP, Not Used	
513515-22	Shipping Assembly CDGS Player, INT, Not Used	
513515-23	Shipping Assembly CDGS Player, LA, NTSC	
513515-24	Shipping Assembly CDGS Player, PD, Not Used	
513515-25	Shipping Assembly CDGS Player, LA, PAL	
513515-26	Shipping Assembly CDGS Player, LA, Brazil	
513515-27	Shipping Assembly CDGS Player, SI	
364346-02	Box, Accessory	
364055-03	Master Shipping Box	4 Up
364056-03	Packing Box	1 Up
365302-01	Tray, Packing	
365158-01	Main Assembly (PAL)	
365158-02	Main Assembly (NTSC)	
365299-01	Endcap	
1540025-01	Poly Bag	
324257-02	Bag, Drying Agent	
904778-01	RF Switch Box	
326189-01	Cable, RF (NTSC)	
251846-04	Cable, RF (PAL)	
311945-01	Cable Assembly, Audio	
365183-01	Game Controller	
313375-01	Power Supply, UL/CSA	110V
313375-02	Power Supply, BSI	240V
313375-03	Power Supply, VDE	220V
313375-04	Power Supply, SEV	220V
313375-05	Power Supply, SAA	220V
313375-06	Power Supply, Brazil	220V
371189-01	Consumer Information Sheet	Multilingual
318896-05	Software License Agreement	English
318708-02	Software License Agreement	German
318365-04	Warranty Card	US
318882-02	Warranty Card	CN
320046-06	Warranty Card	GR
325254-01	Warranty Card	FR

Shipping Assembly CDGS Player (513515 Rev C)		(cont'd)
369270-01	Warranty Card	UK
318876-03	Service Center List	AL
368084-01	Seal, Tamper Evident	
318143-02	Glue, White	
999104-01	Adhesive Tape, Transparent, 50mm	
369632-01	Label, UPC	
366648-01	Label, Bar Code, 0.5" X 1.75"	
371133-01	User's Guide, CDGS Player	UK Eng
371208-01	User's Guide, CDGS Player	US Eng
371212-01	User's Guide, CDGS Player	FR
371214-01	User's Guide, CDGS Player	GR
371213-01	User's Guide, CDGS Player	IT
371219-01	User's Guide, CDGS Player	NE
371220-01	User's Guide, CDGS Player	DN/NR
371216-01	User's Guide, CDGS Player	SD/FN
371215-01	User's Guide, CDGS Player	SP/PG
365300-01	Sleeve, Color	US
365300-02	Sleeve, Color	CN
365300-03	Sleeve, Color	UK
365300-04	Sleeve, Color	GR
365300-05	Sleeve, Color	FR
365300-06	Sleeve, Color	IT
365300-07	Sleeve, Color	SP
365300-08	Sleeve, Color	SG
365300-09	Sleeve, Color	SF
365300-10	Sleeve, Color	AU
365300-11	Sleeve, Color	NR
365300-12	Sleeve, Color	SD
365300-13	Sleeve, Color	FN
365300-14	Sleeve, Color	NE
365300-15	Sleeve, Color	DN
365300-16	Sleeve, Color	BF
365300-17	Sleeve, Color	BD
365300-18	Sleeve, Color	AL
365300-19	Sleeve, Color	CEL
365300-20	Sleeve, Color	PG
365300-23	Sleeve, Color	LA, NTSC
365300-25	Sleeve, Color	LA, PAL
365300-26	Sleeve, Color	Brazil
365300-27	Sleeve, Color	SI

In memory to Jay Miner and all developers of the Amiga system! Let the spirit survive!

Any commercial use of this material is prohibited!